

Chair Assembly Instructions

Your chair comes packaged in one box.

DO NOT use any sharp objects to open plastic wrapped components as damage to product or components may result.





Carefully remove all of the components from the packaging and set aside for assembly. Assemble on a soft surface to prevent scratching the finish.

Estimated Assembly Time in Minutes

★ ☆ ☆
 <15 <45 60+



Parts List

<p>A 1 x Seat</p> 	<p>* D 2 x Back Legs</p> 
<p>B 1 x Back</p> 	<p>* E 4 x Washers</p> 
<p>* C 2 x Front Legs</p> 	<p>* Replaceable Parts</p>

Assembly

Step 1

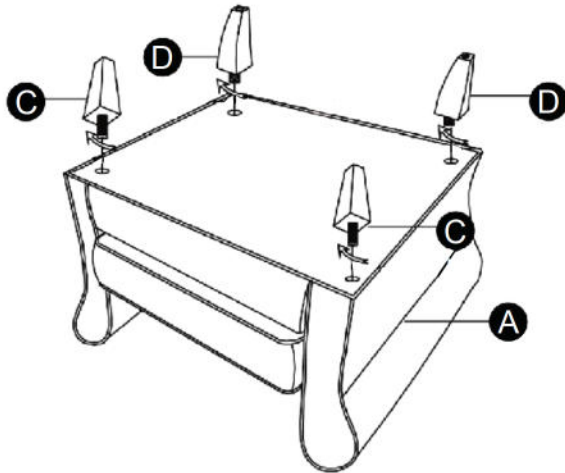

Step 2

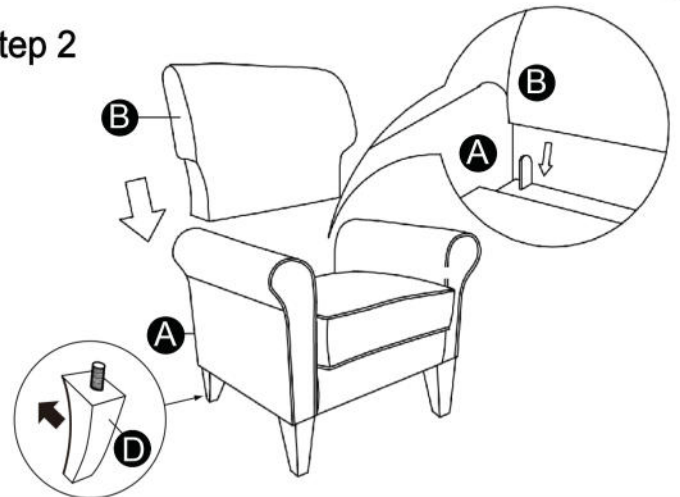

Step 3

OPTIONAL

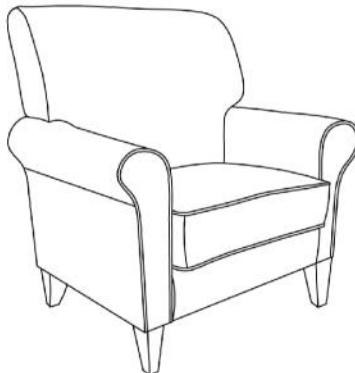
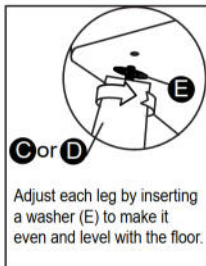

Your style may differ from images. Care for your furniture by periodically tightening all legs.

CAUTION: Tighten all components securely before use. Failure to do so may result in personal injury.

About your furniture piece:

- Softening of foam is natural and will happen over time with use.
- Fabric will fade or discolor in direct sunlight. Minimize exposure to direct sunlight to extend the life of your furniture.
- Wood grain, knots, streaks, and color variation occur naturally in wood and are not considered defects.

Customer Support: 866-238-0531
 Mon-Fri 8:00am - 4:30pm CST
customerservice@furniturequestions.com