



LITTLE GREEN® PORTABLE CARPET & UPHOLSTERY CLEANER MODEL 3860

Important Safety Instructions.....	2	Using Your Machine.....	5
What's in the Box?	3	Emptying the Dirty Water Tank.....	6
Assembly	3	After-Cleaning Care.....	7
Filling the Formula Tank.....	4	Warranty	7

Product Overview

- A. Power Switch
- B. Dirty Tank Lid
- C. Dirty Tank Handle
- D. Dirty Tank (Float Stack inside)
- E. Carry Handle
- F. Clean Tank Handle
- G. Power Cord Wrap
- H. Hose
- I. Hose Clip

Tools & Accessories

Accessories vary by model.
Check the "Carton Contents"
on the top flap to see what's
included with your purchase.

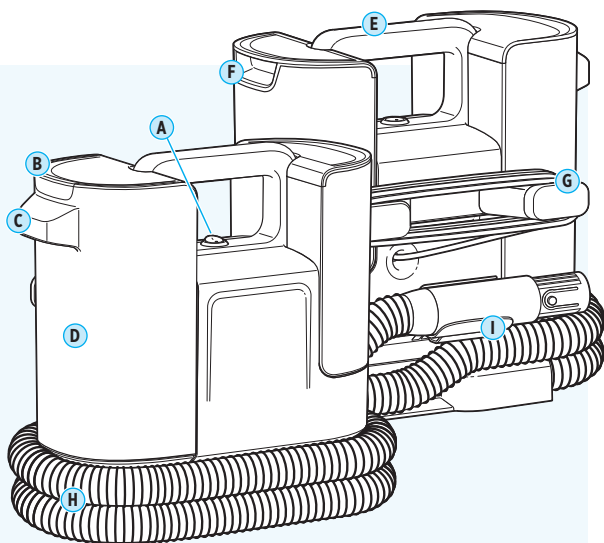

Meet your new BISSELL® product!

Go to support.BISSELL.com for a walkthrough of your new purchase, including videos, tips, support, and more. Want to get started right away? This guide has all the information you need to set up your new product. Let's take a look...

IMPORTANT SAFETY INSTRUCTIONS



READ ALL INSTRUCTIONS BEFORE USING YOUR APPLIANCE.

When using an electrical appliance, basic precautions should be observed, including the following:



WARNING

TO REDUCE THE RISK OF FIRE, ELECTRIC SHOCK OR INJURY:

- Do not leave appliance when it is plugged in. Unplug from outlet when not in use and before servicing.
- Use indoors only.
- Always install float before any wet pick-up operation.
- Use only cleaning products intended for use with this appliance to prevent internal component damage. See the Cleaning Formulas section of this guide.
- Do not allow to be used as a toy. Close attention is necessary when used by or near children.
- Do not use for any purpose other than described in this user guide. Use only manufacturer's recommended attachments.
- Do not use with damaged cord or plug. If appliance is not working as it should, has been dropped, damaged, left outdoors, or dropped into water; do not attempt to operate it and have it repaired at an authorized service center.
- Do not pull or carry by cord, use cord as a handle, close door on cord, or pull cord around sharp edges or corners. Do not run appliance over cord. Keep cord away from heated surfaces.
- Do not unplug by pulling on cord. To unplug, grasp the plug, not the cord.
- Do not handle plug or appliance with wet hands.
- Do not put any object into openings. Do not use with any opening blocked; keep openings free of dust, lint, hair, and anything that may reduce air flow.
- Keep hair, loose clothing, fingers, and all parts of body away from openings and moving parts of the appliance and its accessories.

- Turn OFF all controls before plugging or unplugging appliance.
- Use extra care when cleaning on stairs.
- Do not use to pick up flammable or combustible materials (lighter fluid, gasoline, kerosene, etc.) or use in areas where they may be present.
- Unplug before connecting the 4" Tough Stain Cleanout Tool.
- If the appliance has a hand-held accessory like pet brush, motor driven head, etc. the user shall avoid entrapment.
- Do not pick up anything that is burning or smoking, such as cigarettes, matches, or hot ashes.
- Do not use without filters in place.
- Do not apply liquid directly to any person or animal.
- Do not turn your appliance ON until you are familiar with all instructions and operating procedures.
- Keep appliance on a level surface.
- Do not carry the vacuum cleaner while in use.
- Liquid must not be directed towards equipment containing electrical components.
- Do not use appliance in an enclosed space filled with vapors given off by oil-based paint, paint thinner, some moth-proofing substances, flammable dust, or other explosive or toxic vapors.
- Do not use to pick up toxic material (chlorine bleach, ammonia, drain cleaner, etc.)
- Plastic film can be dangerous. To avoid danger of suffocation, keep away from children.
- Reduce The Risk Of Electric Shock – Do not expose to rain. Store indoors.
- Connect to a properly grounded outlet only. See Grounding Instructions.

SAVE THESE INSTRUCTIONS

THIS MODEL IS FOR HOUSEHOLD USE ONLY.

COMMERCIAL USE OF THIS UNIT VOIDS THE MANUFACTURER'S WARRANTY.



WARNING

Improper connection of the equipment-grounding conductor can result in a risk of electrical shock. Check with a qualified electrician or service person if you aren't sure if the outlet is properly grounded. **DO NOT MODIFY THE PLUG.** If it will not fit the outlet, have a proper outlet installed by a qualified electrician. This appliance is designed for use on a nominal 120-volt circuit, and has a grounding attachment plug that looks like the plug in the illustration. Make certain that the appliance is connected to an outlet having the same configuration as the plug. No plug adapter should be used with this appliance.

GROUNDING INSTRUCTIONS

This appliance must be connected to a grounded wiring system. If it should malfunction or break down, grounding provides a safe path of least resistance for electrical current, reducing the risk of electrical shock. The cord for this appliance has an equipment-grounding conductor and a grounding plug. It must only be plugged into an outlet that is properly installed and grounded in accordance with all local codes and ordinances.

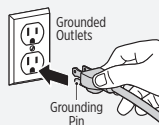

IMPORTANT INFORMATION

- To reduce the risk of a leaking condition, do not store where freezing may occur.

Assembly

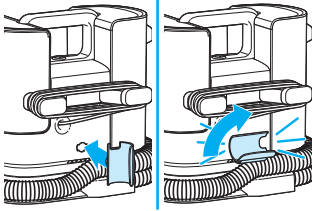

1. To install hose clip, insert into back of machine and rotate clockwise until it clicks.

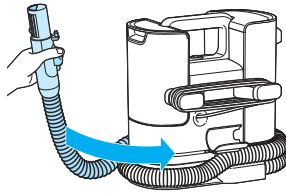

2. Wrap hose around bottom of machine and place on hose clip.

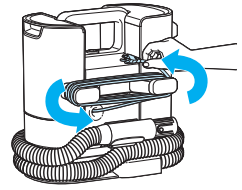

3. Wrap the cord around the designated cord wrap, as shown.

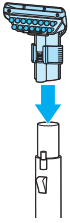

4. Attach the tool.

Filling the Formula Tank

This machine is compatible with BISSELL® formulas made for portable carpet cleaners. Always use genuine BISSELL formulas in your machine. Use of other cleaning formulas may harm the machine.

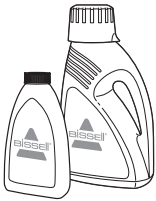

1. Choose your formula.*

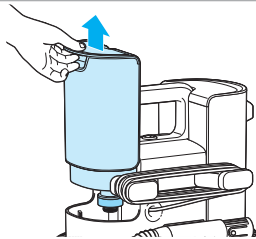

2. Remove clean tank by gripping handle and lifting up.

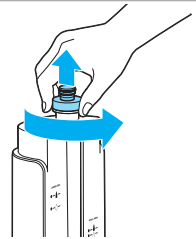

3. Unscrew cap.

CONTINUED ON NEXT PAGE ➔

Filling the Formula Tank (continued)

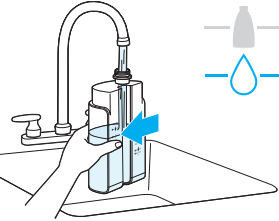
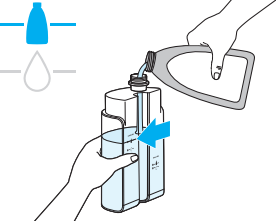
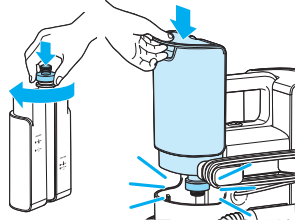
		
<p>4. Add water to the appropriate fill line based on the size of your mess.</p> <p>Small Area: 14 oz Large Area: 28 oz</p>	<p>5. Add formula to the corresponding fill line.</p> <p>Small Area: 2 oz Large Area: 4 oz</p>	<p>6. Tighten cap back into place. Align clean tank with groove on machine and slide down until it clicks.</p>

***Compatible BISSELL formulas include:** PET PRO Oxy Spot & Stain, Advanced PET Spot & Stain, OXYGEN BOOST, Simply Spot & Stain Pet

⚠ WARNING To reduce the risk of fire and electric shock due to internal component damage, use only BISSELL cleaning formula intended for use with this machine.

Using Your Machine

Before You Clean:

- Vacuum to remove loose dirt from areas to be cleaned.
- Spray any BISSELL stain pretreat formula on soiled areas and allow to sit for a few minutes.
- Tip: For upholstery, work in small sections until area is clean.

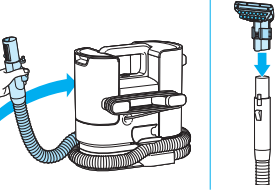
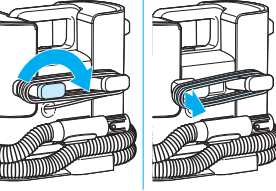
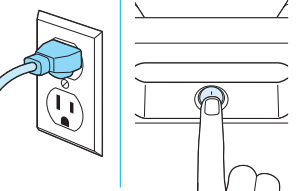
		
<p>1. Unwrap hose. Attach your desired tool to end of hose grip until it clicks.</p>	<p>2. Unwrap cord.</p>	<p>3. Plug into a grounded outlet. To turn the machine on, flip the power switch to ON (I).</p>

CONTINUED ON NEXT PAGE ➡

Using Your Machine (continued)

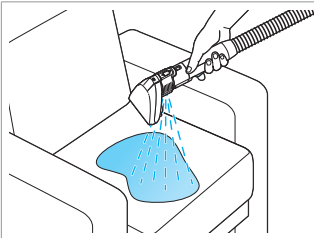

4. While holding tool above desired area, press and hold trigger to spray solution.

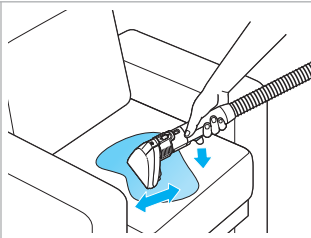

5. Release spray trigger and gently scrub stain using bristles.

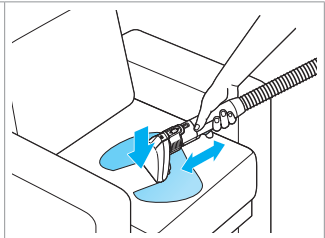

6. With trigger released, press tool firmly against surface and pull towards you to remove stain. Repeat as needed.

Cleaning with the 2-in-1 Tough Stain Tool

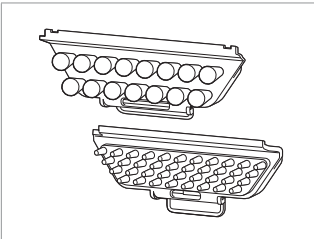

1. Choose your cleaning method: Use the bristle block for everyday soft surface cleaning, or the rubberized block to remove embedded pet hair and debris.



2. Turn machine OFF and remove tool lens.

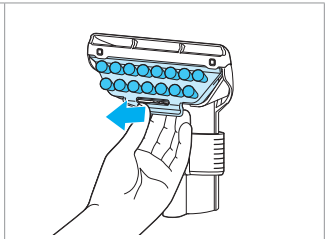

3. Pull bottom latch to release bristle block from tool.

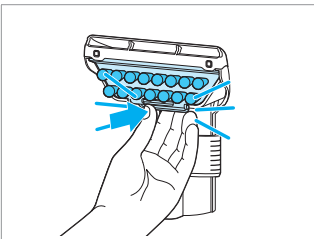

4. Insert your preferred tool attachment; it will click into place.



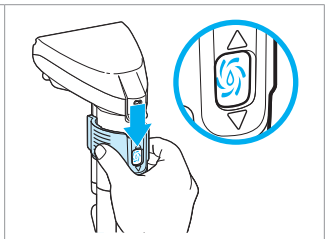

5. Reinstall the lens.

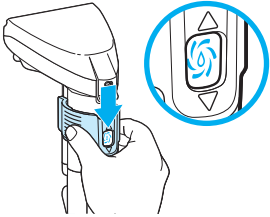

6. Slide tool lever up to ensure tool is in SPRAY mode. Follow steps 4-6 above to clean.

Cleaning the Machine with the 2-in-1 Tough Stain Tool

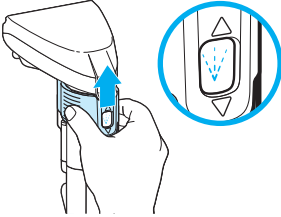
		
<p>1. Turn machine ON. Slide tool lever down for cleanout mode.</p>	<p>2. Press the trigger to activate the CLEANOUT function. Solution mixture will come through the tool and the hose.</p>	<p>3. To continue cleaning with your machine, slide the tool's lever upward to return to SPRAY mode.</p>

Emptying the Dirty Water Tank

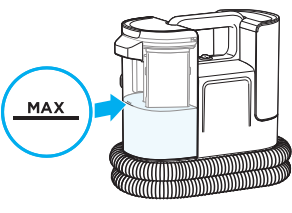
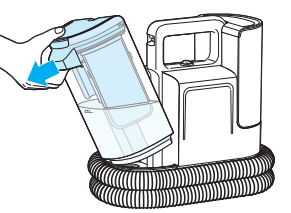
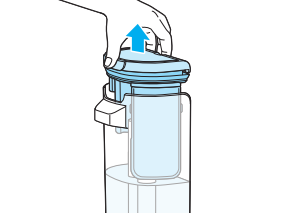
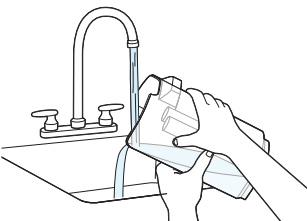
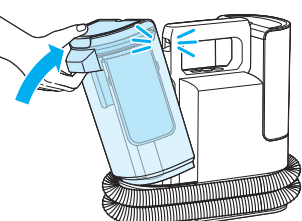
		
<p>1. Empty dirty water tank when "MAX" fill line is reached. Do not allow water level to exceed MAX fill line.</p>	<p>2. Tilt and pull away dirty water tank to remove from machine.</p>	<p>3. Pull up on dirty tank lid to remove.</p>
		
<p>4. Pour out dirty water and rinse tank.</p>	<p>5. Allow tank and lid to air dry. Reinstall tank lid.</p>	<p>6. Place cap onto tank and tighten. Align tank with machine and press down until it clicks into place.</p>

After-Cleaning Care

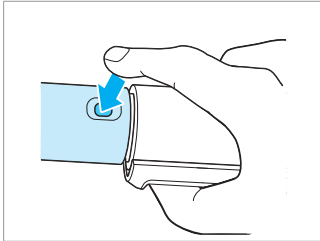

1. To disconnect tools, push down on button above hose grip and pull straight off. (Do NOT twist tool to remove it.)

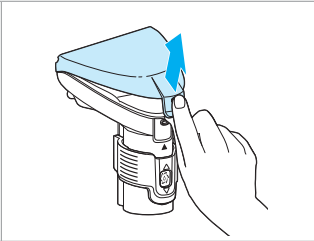

2. Remove tool lens.

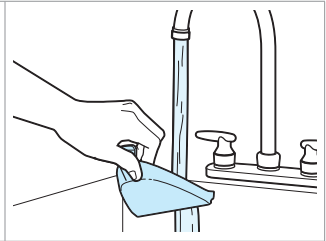

3. Rinse lens under clean, running water. Allow to dry before reinstalling.

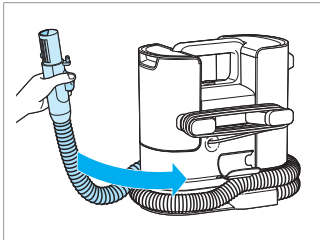

4. Wrap hose for storage. Store indoors in a secure, dry location.

Note: Other maintenance or service not included in this manual should be performed by an authorized service representative.

Warranty

Limited 3-year warranty, may vary by state. Visit support.BISSELL.com or call 1-800-237-7691 for complete warranty information.

NOTICE: To reduce the risk of a leaking condition, do not store where freezing may occur. Damage to internal components may result. Store machine in protected, dry area at room temperature (40°F - 104°F).



We're Waggin' Our Tails!

BISSELL proudly supports BISSELL Pet Foundation® and its mission to help save homeless pets. When you buy a BISSELL® product, you help save pets, too. We're proud to design products that help make pet messes, odors and pet homelessness disappear.

Visit [BISSELLsavespets.com](https://www.bissellsavespets.com) to learn more.

But wait, there's more!

Join us online for a complete guide to your new product, including troubleshooting, product registration, parts, and more.

Go to [support.BISSELL.com](https://support.bissell.com).



REGISTER



INFO



VIDEOS



PARTS



SUPPORT



©2024 BISSELL Inc. All rights reserved.
Part Number 1638685 11/23 v6