

**KEURIG®**

# K·Supreme Plus® SE

## Use & Care Guide

Get the most from your  
new Keurig® brewer

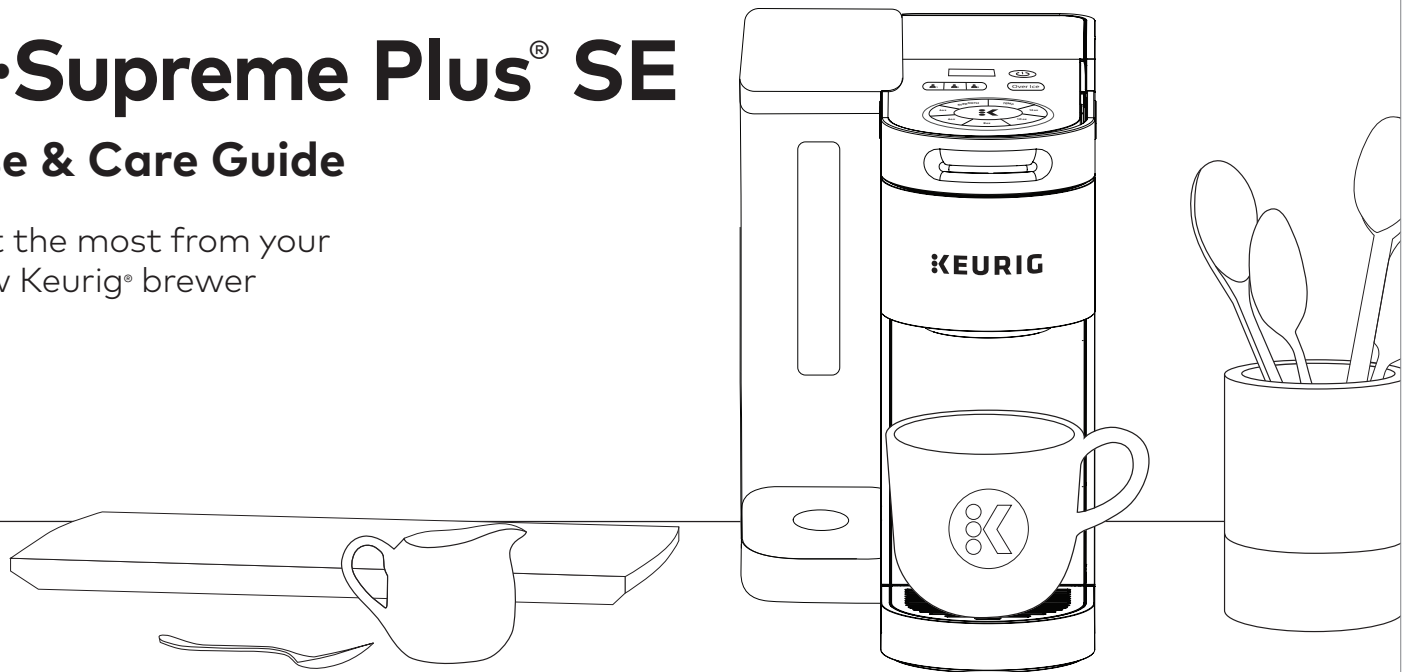

# Before You Brew

## 1 Plug & Place

Remove packing tape from brewer. Plug into a grounded outlet.

Place a large mug (10 oz minimum) on the drip tray.

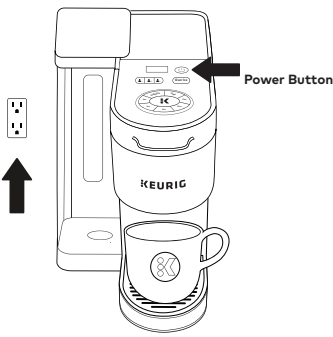

## 3 Lift & Lower

Lift and lower the handle. **Do not insert a K-Cup® pod.** The brewer will power on automatically.

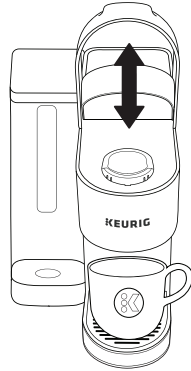

## 2 Rinse & Fill

Remove the water reservoir lid, then lift the reservoir straight up to remove it. If you have a Keurig® Water Filter, install it now. Refer to your Water Filter Starter Kit for instructions.

Rinse reservoir with fresh water and fill to the **MAX FILL** line.

Replace water reservoir. Replace lid.

**NOTE:** Do not use distilled water.

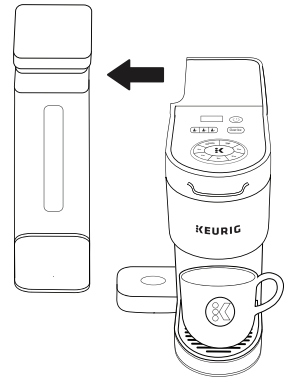

## 4 Cleansing Brew

The 5 cup sizes will blink. Press the **8 oz** button, then press the blinking **BREW** button to start a cleansing brew. Pour the hot water into the sink.

**The one-time setup process is now complete and you are ready to brew!**

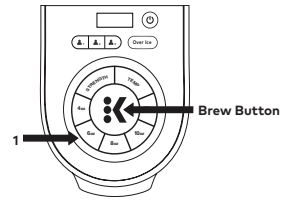

# Brew Your First Cup

## 5 Place Mug & Pod

Place a mug on the drip tray. If using a travel mug, remove the drip tray and place the mug on the drip tray base. Lift the handle and place a K-Cup® pod in the K-Cup® pod holder. Lower the handle completely to close the lid.

**Do not remove the foil lid on the K-Cup® pod.**



## 6 Brew & Enjoy!

The 5 brew size buttons will blink. Select your brew size, then press the blinking **BREW** button. The **BREW** button will remain illuminated while brewing. Brewing is complete when the buttons are no longer illuminated. Lift the handle and dispose of the K-Cup® pod.

**CAUTION:** While brewing, there is extremely hot water in the K-Cup® pod holder. To avoid injury, do not lift the handle during the brewing process.

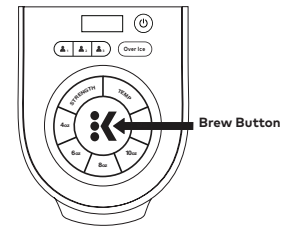

**For bolder coffee,** press the **STRENGTH** button until you have reached the desired level of strength, then select brew size, followed by the **BREW** button.

**STRENGTH** ■■■■■

**For hotter coffee,** press the **TEMP** button until you have reached the desired level of heat, then select brew size, followed by the **BREW** button.

**TEMP** ■■■■■

**For iced beverages,** fill a large plastic tumbler with ice. Insert any K-Cup® pod, then press the **OVER ICE** button, followed by the **BREW** button.

**NOTE:** Choose a tumbler large enough to accommodate both the ice and dispensed liquid to prevent overflow. Do not brew over ice in glass.

**To set a preference,** use the 3 user profile buttons. Once the desired brew size, strength, and temperature settings are chosen, press and hold one of the user profile buttons to save your settings.

Once saved, you can press the user profile button, followed by the **BREW** button.



## Brewer Features

**Smart Start** heats and brews in one simple process. No need to wait for the brewer to heat before selecting brew size. Simply power on your brewer by lifting the handle, inserting a K-Cup® Pod, selecting your brew size, and pressing the **BREW** button. The brewer will heat, then automatically begin brewing.

**Auto Off** automatically turns your brewer off 5 minutes after the last brew for energy savings.

**High Altitude** To ensure your brewer works properly at higher altitudes (5,000 feet), enable the High Altitude setting by pressing and holding the **BREW** button and **8 oz** buttons for 3 seconds.

### ATTENTION!

This brewer is only compatible with newly designed Keurig® My K-Cup® Universal Reusable Coffee Filter.

Do not attempt to use any other reusable filter or previous versions of Keurig® My K-Cup® Universal Reusable Coffee Filter; may cause damage to brewer.



# Caring For Your Brewer

Regular cleaning keeps your brewer running smoothly. Always be sure to turn off and unplug your brewer before cleaning.



## Brewer Exterior

Keep your Keurig® brewer looking its best by cleaning the exterior from time to time. Just clean the metal areas with a paper towel and a nonvinegar glass cleaner, and the plastic with a damp, soapy, lint-free, nonabrasive cloth. Never immerse the brewer in water or other liquids.

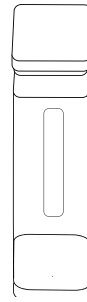

## Water Reservoir

The water reservoir should be cleaned periodically by wiping the inside of the reservoir and underside of the lid with a damp, nonabrasive, lint-free cloth. Do not dry the inside of the water reservoir with a cloth, as lint may remain. Allow the reservoir to dry completely.

## Drip Tray

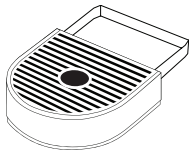

The drip tray can hold up to 8 ounces of overflow and should be emptied and cleaned occasionally. To remove, slide it toward you, keeping it level to avoid spilling. Rinse and clean with a damp, soapy, lint-free, nonabrasive cloth.

## Regular Maintenance

For great-tasting coffee, keep your brewer running at peak performance by following the recommended maintenance schedule:

Frequency	Product	Benefit
Weekly	Keurig® Rinse Pods	Rinse away residue and oils for a great-tasting cup of coffee every time
Every 2 months	Keurig® Water Filters	Keep your water fresh and clean to enhance the taste of your coffee
Every 3 months or when the Descale notification turns on*	Keurig® Descaling Solution	Eliminate mineral buildup to enhance the taste of your coffee and preserve the long-term health of your coffeemaker

\*To turn off Descale notification, follow the full descaling procedure as outlined in the Use & Care Guide.

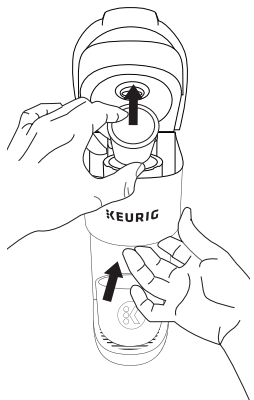

## K-Cup® Pod Holder

To remove the K-Cup® pod holder from the brewer, lift the handle and grasp the top of the K-Cup® pod holder with one hand while pushing up on the bottom of the K-Cup® pod holder from underneath with the other hand until it releases. After cleaning, align the K-Cup® pod holder with the opening, using the two front ribs as a guide, and snap into place from the top.

**CAUTION:** There are sharp needles that puncture the K-Cup® pod above the K-Cup® pod holder and in the bottom of the K-Cup® pod holder. To avoid risk of injury, do not put your fingers in the K-Cup® pod holder.

**NOTE:** Always remove and dispose of the used K-Cup® pod after brewing.

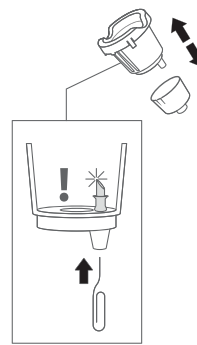

## Exit Needle

Remove the pod holder assembly and detach the funnel. Locate the exit needle on the inside bottom of the K-Cup® pod holder. Insert a straightened paper clip into the exit needle to loosen any coffee grounds.

## Funnel

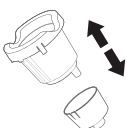

Washing the funnel ensures a fresh beverage experience. The funnel should be washed regularly and can be removed from the K-Cup® pod holder by pulling on it until it pops off. To replace it, orient the snaps to the indent and just snap it back onto the K-Cup® pod holder.

## Entrance Needles

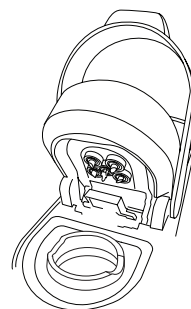

Lift the brewer handle and locate the entrance needles on the underside of the lid. To clean the holes in the needles, hold the brewer handle in the upward position and with your other hand, carefully insert a straightened paper clip into all the holes. Gently move it around to loosen any coffee grounds. Lower the handle completely and run a cleansing brew two times. Do not insert a K-Cup® pod.

# Descaling Your Brewer

You should descale your brewer every 3 months or when the descale notification turns on. Properly follow the descaling procedure in order to turn off the notification.

Depending on the mineral content of your water, calcium deposits or scale may build up in your brewer. Scale is nontoxic, but if left unattended can hinder brewer performance. Regularly descaling your brewer every 3 months helps maintain the heating element and other internal parts that come in contact with water. Calcium deposits may build up faster, making it necessary to descale more often.

## Descaling Procedure

Before you begin, you will need a large ceramic mug, fresh water, Keurig® Descaling Solution, and access to a sink. Do not use a paper cup. Ensure that there is no beverage pod in the K-Cup® pod holder. Please allow approximately 15-20 minutes for the descaling procedure.

### STEP 1: Prepare the Brewer

Pour the entire bottle of Keurig® Descaling Solution into an empty water reservoir. Then, fill the empty bottle with water and pour into the water reservoir.

**Do not insert a K-Cup® pod.** Place a large mug on the drip tray.

### STEP 2: Descale the Brewer

To activate Descale Mode, begin with the brewer plugged in and powered off, then press and hold the **8 oz** and **12 oz** buttons together for 3 seconds. When flashing, press the **BREW** button to start the descaling process. Once the brew is complete, pour the hot liquid into the sink. Repeat this step until the **ADD WATER** light illuminates.

### STEP 3: Fresh Water Rinse

Empty the water reservoir and refill to the **MAX FILL** line with fresh water. When flashing, press the **BREW** button to start the rinsing process. Once the brew is complete, pour the hot liquid into the sink. Repeat this step until the **DESCALE** notification turns off. The brewer has now exited Descale Mode and is ready for use!

**NOTE:** The cleaning action of Keurig® Descaling Solution may result in a "foam" dispensed from the brewer. This is natural, as the solution is reacting with the scale inside. For a brewer that is heavily scaled, the brewer may not fill properly after the descaler is added. If this occurs, you may see only a small amount or no output dispensed, followed by the sound of air blowing out. If this occurs:

- Turn off and unplug the brewer.
- If there is Keurig® Descaling Solution in the water reservoir, discard the contents, rinse the water reservoir thoroughly, and refill with water.
- Plug the brewer back in, power on, and repeat the Step 3 Fresh Water Rinse cycle. The brewer should begin to function normally as the solution is rinsed out and the scale is removed. If problem persists, allow brewer to sit unplugged for at least 30 minutes before continuing with the rinse.

---

# Troubleshooting

## Grounds in Your Coffee

Grounds may have gathered in the exit or entrance needles and can be cleaned using a straightened paper clip or similar tool.

- Clean the exit needle of the K-Cup® pod holder. Refer to the exit needle care instructions.
- Clean the brewer entrance needles. Refer to the entrance needles care instructions.

For optimal enjoyment and to limit grounds in your cup during hot water brews or when transitioning from brewing a coffee pod to a non-coffee pod (e.g., tea or cocoa), clean the exit and entrance needles per the instructions provided and perform 2 cleansing brews.

## Brewer Will Not Brew

- A minimum of 6 oz of water is required to brew. Add an additional 2 oz of water to the reservoir to ensure the minimum fill level has been met, then press the **BREW** button. Repeat until the brewer begins to dispense.

## Brewing a Partial Cup

- Power the brewer off. Press and hold the **BREW** button and **12 oz** button for 5 seconds until water starts dispensing. Then release and let the water purge. Discard the contents into the sink. Press the power button to restart.
- The exit needle may be clogged. Refer to the exit needle care instructions.

- Clean the K-Cup® pod holder; see K-Cup® pod holder care instructions.
- The brewer may need to be descaled. If you have repeated the descale procedure on your brewer two times and it is still only brewing a partial cup, contact customer service.

## Brewer Does Not Have Power or Shuts Off

- Make sure that the power button has been turned on.
- Plug brewer into its own grounded outlet. If the electric circuit is overloaded with other appliances, your brewer may not function properly. The brewer should be operated on its own circuit, separate from other appliances.
- For energy savings, the brewer automatically turns off 5 minutes after the last brew. Press the power button to restart.
- If the brewer still doesn't have power, contact customer service.

## Helpful Hints

Water quality varies greatly. If you notice an undesirable taste in your beverage (such as chlorine or mineral tastes), we recommend using bottled or filtered water. Do not use distilled water.

## Service

Beyond these recommended cleaning and maintenance procedures, this brewer is not user-serviceable. For service, please refer to the Warranty section of this guide.

## Storage

Empty the water reservoir before storing or transporting and take care to ensure that you store your brewer in a safe and frost-free environment. When you prepare to use it after storage, we recommend rinsing the water reservoir with fresh water and descaling the brewer as detailed in the Descaling Your Brewer section.

If you plan to move your brewer to a different location, turn the brewer off, unplug it, and empty the water reservoir. If your brewer has been in an environment below freezing, please be sure to let it warm to room temperature for at least 2 hours before using.

# Click or Call!

## Have Questions?

We're here to help. Visit [support.keurig.com](https://support.keurig.com) for step-by-step videos on cleaning, descaling, and more.



## Still Need Help?

Give us a call at  
**1-866-901-BREW (2739).**

# Warranty

## LIMITED ONE-YEAR WARRANTY

Keurig Green Mountain, Inc. (Keurig) warrants that your brewer will be free of defects in materials or workmanship under normal home use for one year from the date of purchase. It is recommended that you register your brewer on [keurig.com/new](https://keurig.com/new) so that your purchase information will be stored in our system. Keurig will, at its option, repair or replace a defective brewer without charge upon receipt of proof of the date of purchase. If a replacement brewer is necessary to service this warranty, the replacement brewer may be new or reconditioned. If a replacement brewer is sent, a new limited one-year warranty will be applied to the replacement brewer.

This warranty only applies to brewers operated in the United States and Canada. This warranty gives you specific legal rights, and you may also have other rights that vary from state to state and, in the case of Canada, from province to province.

Only the use of Keurig® K-Cup® brand pods and accessories will guarantee the proper functioning and lifetime of your Keurig® brewer. Any damage to or malfunction of your brewer resulting from the use of non-Keurig® pods and accessories may not be covered by this warranty or may result in a service fee if the damage or malfunction is determined to be caused by such use.

## WHAT IS NOT COVERED BY THE LIMITED WARRANTY?

THIS WARRANTY DOES NOT COVER CONSEQUENTIAL OR INCIDENTAL DAMAGES SUCH AS PROPERTY DAMAGE AND DOES NOT COVER INCIDENTAL COSTS AND EXPENSES RESULTING FROM ANY BREACH OF THIS WARRANTY, EVEN IF FORESEEABLE. Some states or provinces do not allow the exclusion or limitation of incidental or consequential damages, so the above limitation or exclusion may not apply to you depending on the state or province of purchase.

Nor does this warranty cover damages caused by use of non-Keurig® pods or accessories, services performed by anyone other than Keurig or its authorized service providers, use of parts other than genuine Keurig® parts, or external causes such as abuse, misuse, inappropriate power supply, or acts of God.

## OTHER LIMITATIONS

THIS WARRANTY IS EXCLUSIVE AND IS IN LIEU OF ANY OTHER EXPRESS WARRANTY, WHETHER WRITTEN OR ORAL. IN ADDITION, KEURIG HEREBY SPECIFICALLY DISCLAIMS ALL OTHER WARRANTIES WITH RESPECT TO YOUR KEURIG® BREWER, INCLUDING ANY IMPLIED WARRANTY OF MERCHANTABILITY OR FITNESS FOR ANY PARTICULAR PURPOSE. Some states or provinces do not allow disclaimers of such implied warranties or limitations on how long an implied warranty lasts, so the above limitation may not apply to you depending on the state or the province of purchase.

## HOW DO YOU OBTAIN WARRANTY SERVICE?

Keurig® brewers are high-quality appliances and, with proper care, are intended to provide years of satisfying performance. However, should the need arise for warranty servicing, simply call Keurig Customer Service at our toll-free phone number, 1-866-901-BREW (2739). Please do not return your brewer for servicing without first speaking to Keurig Customer Service to obtain a Return Materials Authorization (RMA) number. Keurig® brewers returned without an RMA number will be returned to the sender without servicing.

# K·Supreme Plus® SE

SINGLE SERVE COFFEE MAKER

- A. Handle
- B. K-Cup® Pod Holder (B and C are the K-Cup® Pod Holder Assembly)
- C. Funnel
- D. K-Cup® Pod Assembly Housing
- E. Drip Tray Plate
- F. Drip Tray
- G. Drip Tray Base
- H. Water Reservoir Lid
- I. Water Reservoir

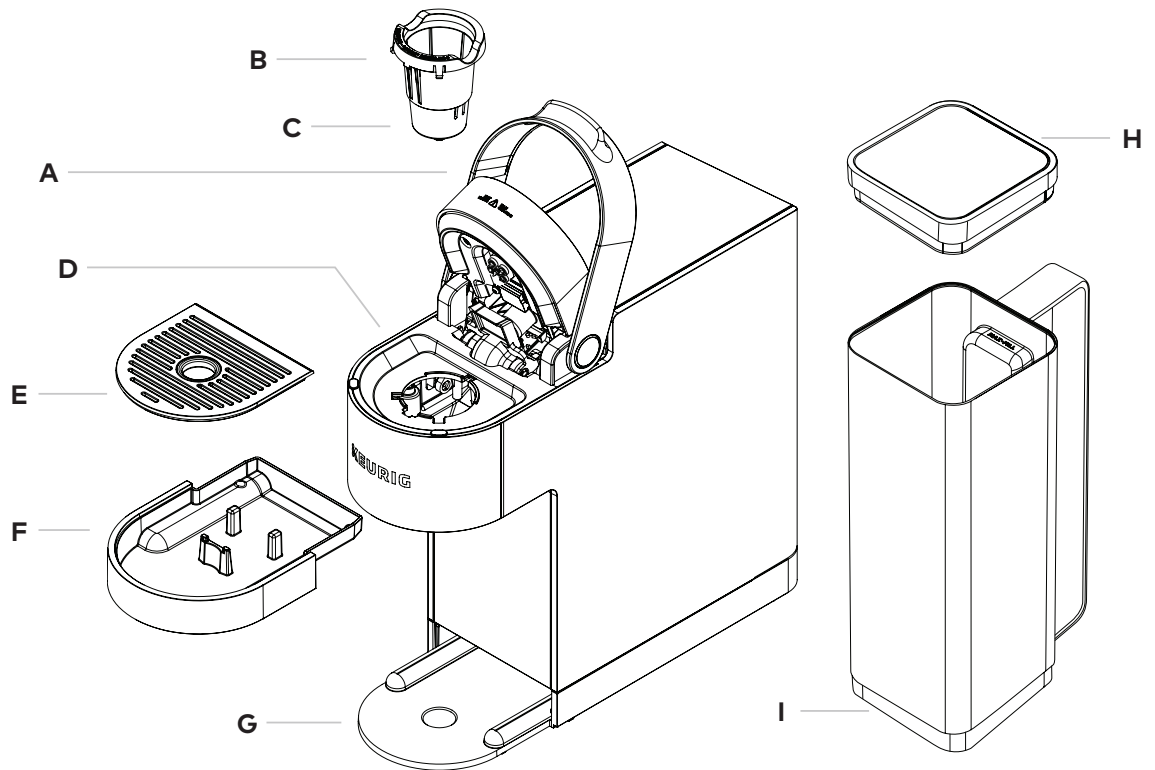

For replacement parts, please visit [www.keurig.com](http://www.keurig.com).

## Coffeehouse taste in your own home.

### FIND YOUR PERFECT POD

With over 75 brands and hundreds  
of varieties, find your match at

[keurig.com/new](http://keurig.com/new)