

CROSSWAVE® HYDROSTEAM™ ALL-IN-ONE MULTI-SURFACE CLEANER

3515 AND 3518 SERIES

Important Safety Instructions2
Warranty3
What's in the Box?.....3
Assembly3
Changing the Brush Roll4
Filling the Clean Water Tank5
Controls and Cleaning Modes.....6
Cleaning Your Floors7
Sanitizing Hard Floors.....7
Emptying the Dirty Water Tank.....8
Using the Clean Out Cycle8
After-Cleaning Care9
Storing Your Machine9
Troubleshooting.....10

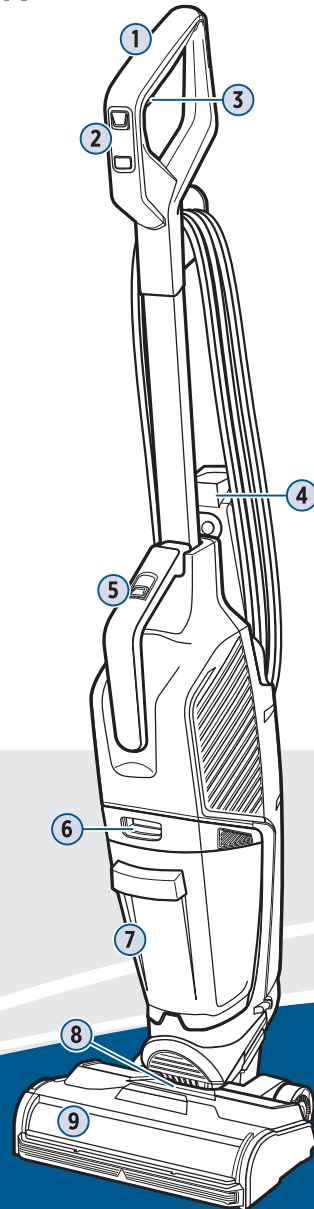

Product Overview

- | | |
|-------------------------------------|--|
| 1. Upper Handle | 6. Dirty Water Tank Removal Button |
| 2. Fingertip Controls | 7. Dirty Water Tank with Filter and Strainer |
| 3. Solution and Steam Spray Trigger | 8. Control Panel |
| 4. Clean Water Tank | 9. Brush Roll Window |
| 5. Clean Out Cycle Button | |

Meet your new BISSELL® product!

Go to support.BISSELL.com for a comprehensive walkthrough of your new purchase, including videos, tips, support, and more. Want to get started right away? This guide has all the information you need to set up your new product. Let's take a look...



IMPORTANT SAFETY INSTRUCTIONS



READ ALL INSTRUCTIONS BEFORE USING YOUR APPLIANCE.

When using an electrical appliance, basic precautions should be observed, including the following:

WARNING

TO REDUCE THE RISK OF FIRE, ELECTRIC SHOCK OR INJURY:

- Connect to a properly grounded outlet only. See grounding instructions. Do not modify the three-prong grounded plug.
- Do not leave appliance when it is plugged in. Unplug from outlet when not in use and before servicing.
- Use indoors only.
- Do not immerse. Use only on surfaces moistened by cleaning process.
- Always install float before any wet pick-up operation.
- Use only BISSELL® cleaning products intended for use with this appliance to prevent internal component damage. See the Cleaning Formulas section of this guide.
- Do not allow to be used as a toy. Close attention is necessary when used by or near children.
- Do not use for any purpose other than described in this user guide. Use only manufacturer's recommended attachments.
- Do not use with damaged cord or plug. If appliance is not working as it should, has been dropped, damaged, left outdoors, or dropped into water; do not attempt to operate it and have it repaired at an authorized service center.
- Do not pull or carry by cord, use cord as a handle, close door on cord, or pull cord around sharp edges or corners. Do not run appliance over cord. Keep cord away from heated surfaces.
- Do not unplug by pulling on cord. To unplug, grasp the plug, not the cord.
- Do not handle plug or appliance with wet hands.
- Do not put any object into openings. Do not use with any opening blocked; keep openings free of dust, lint, hair, and anything that may reduce air flow.
- Keep hair, loose clothing, fingers, and all parts of body away from openings and moving parts of the appliance and its accessories.
- Turn OFF all controls before plugging or unplugging appliance.
- Use extra care when cleaning on stairs.
- Do not use to pick up flammable or combustible materials (lighter fluid, gasoline, kerosene, etc.) or use in areas where they may be present.
- Do not pick up anything that is burning or smoking, such as cigarettes, matches, or hot ashes.
- Unplug from outlet before filling, rinsing, or cleaning.
- Do not turn over the steam-cleaning nozzle, or touch the surface of the nozzle when using the steam-cleaner.
- Do not apply steam directly to any person or animal.
- Do not touch the steam-cleaning nozzle or adjacent surfaces when steam-cleaning or when the nozzle is heated.
- Use only manufacturer's recommended attachments - use of attachments not provided or sold by BISSELL may cause fire, electric shock or injury.
- Do not turn your appliance ON until you are familiar with all instructions and operating procedures.
- Keep appliance on a level surface.
- Do not leave steam cleaner unattended.
- Do not use appliance in an enclosed space filled with vapors given off by oil-based paint, paint thinner, some moth-proofing substances, flammable dust, or other explosive or toxic vapors.
- Do not use to pick up toxic material (chlorine bleach, ammonia, drain cleaner, etc.)
- Do not pick up hard or sharp objects such as glass, nails, screws, coins, etc.
- Plastic film can be dangerous. To avoid danger of suffocation, keep away from children.

SAVE THESE INSTRUCTIONS

THIS MODEL IS FOR HOUSEHOLD USE ONLY.

COMMERCIAL USE OF THIS UNIT voids THE MANUFACTURER'S WARRANTY.

WARNING

Improper connection of the equipment-grounding conductor can result in a risk of electrical shock. Check with a qualified electrician or service person if you aren't sure if the outlet is properly grounded. DO NOT MODIFY THE PLUG. If it will not fit the outlet, have a proper outlet installed by a qualified electrician. This appliance is designed for use on a nominal 120-volt circuit, and has a grounding attachment plug that looks like the plug in the illustration. Make certain that the appliance is connected to an outlet having the same configuration as the plug. No plug adapter should be used with this appliance.

GROUNDING INSTRUCTIONS

This appliance must be connected to a grounded wiring system. If it should malfunction or break down, grounding provides a safe path of least resistance for electrical current, reducing the risk of electrical shock. The cord for this appliance has an equipment-grounding conductor and a grounding plug. It must only be plugged into an outlet that is properly installed and grounded in accordance with all local codes and ordinances.

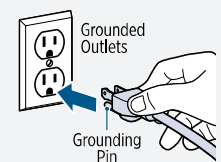

IMPORTANT INFORMATION





- When finished using the product, wrap cord around cord wrap for storage. Store unit indoors in a dry location in an area where the product is not likely to get damaged.
- Any other maintenance or servicing not included in this manual should be performed by an authorized service representative.

Warranty

Limited 3-year warranty, may vary by state. Visit support.BISSELL.com or call 1-844-383-2630 for complete warranty information.

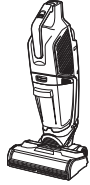

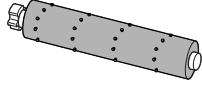
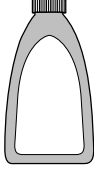
What's in the Box?

Standard accessories may vary by model. To identify what should be included with your purchase, please refer to the "Carton Contents" list located on the carton top flap.

				
Body	Handle	Brush Roll(s)	Trial Formula(s)	Clean-Out and Storage Tray

Assembly

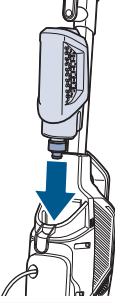
Go to support.BISSELL.com for assembly videos.

		
1. Insert handle into machine.	2. Insert clean water tank into back of machine.	3. Wrap cord. To easily unwrap, turn the Quick Release™ Cord Wrap down.

Changing the Brush Roll

Visit [BISSELL.com](https://www.bissell.com) to purchase additional brush rolls.

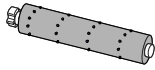

Multi-Surface Brush Roll

Microfibers mop and nylon bristles help remove tough, sticky messes while picking up dry debris.

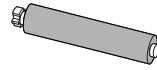

Wood Floor Brush Roll

Soft-touch microfibers gently clean sealed hard floors.

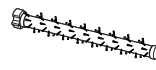

Area Rug Brush Roll

Bristles work on area rugs to pick up dry debris and pet hair.

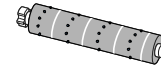

PET Multi-Surface Brush Roll

Microfibers mop and nylon bristles help remove tough, sticky messes while picking up pet hair and dry debris.

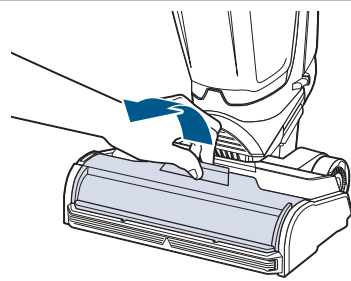

1. Grab the front of the brush roll window and pull upward to remove.

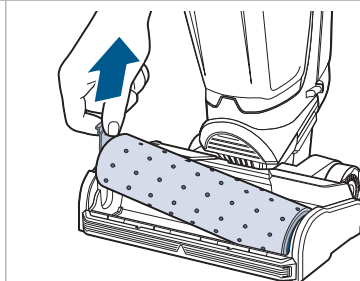

2. Remove the brush roll by pulling the tab.

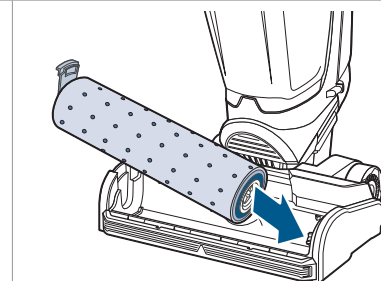

3. Reinstall by placing the end of the brush roll into the right side of the foot.

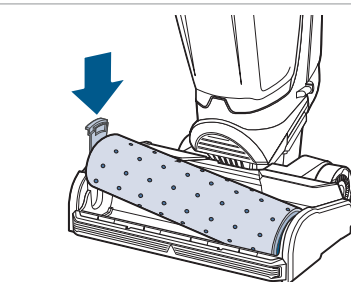

4. Press the tab of the brush roll down so it locks into place.

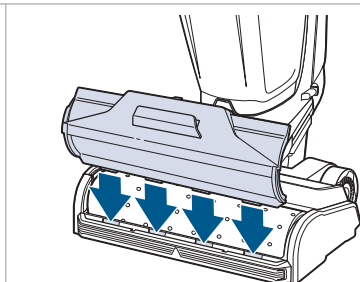

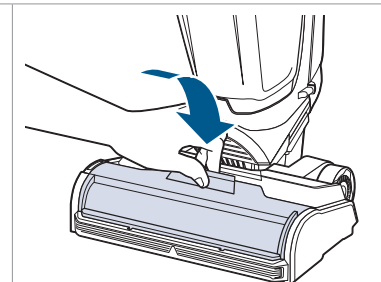

5. Replace the brush roll window by lining up tabs on the edges of the foot.



6. Press the window back so it clicks into place.

Filling the Clean Water Tank

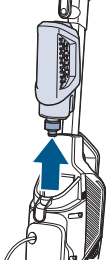
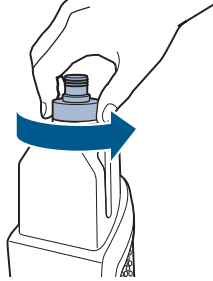
Go to support.BISSELL.com to watch additional how-to videos.

		
<p>1. The clean water tank is located on the back of the machine. To remove, grasp the tank and pull up.</p>	<p>2. Open the top of the clean water tank by removing the screw cap</p>	<p>3. Choose your formula*.</p> <p>Scan the QR code with your smartphone camera or visit BISSELL.com for formulas.</p>

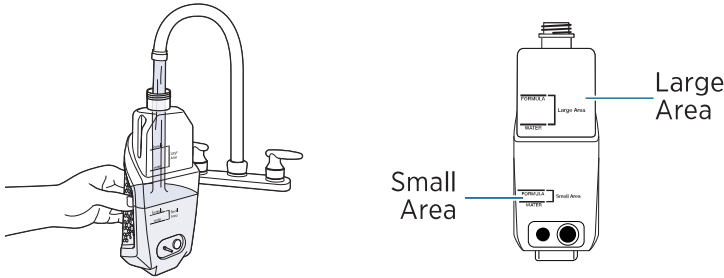
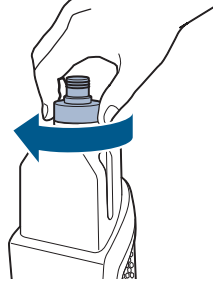
	
<p>4. The clean water tank has a Large Area volume and a Small Area volume. Pick the one that best suits the space that you would like to clean.</p> <p>For large area cleaning (up to 700 sq ft)</p> <ol style="list-style-type: none">Fill clean water tank with warm tap water to the second water fill line (24 fl. oz.).Then add formula to the second formula fill line (4 fl. oz.). <p>For small area cleaning (<350 sq ft)</p> <ol style="list-style-type: none">Fill clean water tank with warm tap water to the first water fill line (12 fl. oz.).Then add formula to the first formula fill line (2 fl. oz.).	<p>5. Close the top of the clean water tank by replacing the screw cap.</p>

***Compatible BISSELL formulas include:** Multi-Surface, Wood Floor, PET Multi-Surface with Febreze Freshness, Hard Floor Sanitize, Simply Multi-Surface Pet
Certain trademarks used under license from The Procter & Gamble Company or its affiliates.

⚠ WARNING To reduce the risk of fire and electric shock due to internal component damage, use only BISSELL cleaning fluid intended for use with the appliance.

Controls and Cleaning Modes

Fingertip Controls

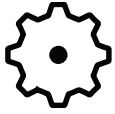

1. Mode

Switch between SteamWash™ mode, hard floor mode, area rug modes. Mode selection appears on the foot display.



2. Power

Turn the machine ON and OFF



3. Clean Out Cycle

Automatic self-cleaning cycle

Foot Display & Cleaning Modes

Mode selection appears on the foot display.
When powered ON, starts in SteamWash mode.



Area Rug Mode

Refresh area rugs and clean dry messes such as crumbs, dirt, hair, and more.



SteamWash™ Mode

Power through tough, stuck-on messes on hard floors and remove dirt on area rug with the power of HydroSteam™ Technology.

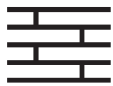

Hard Floor Mode

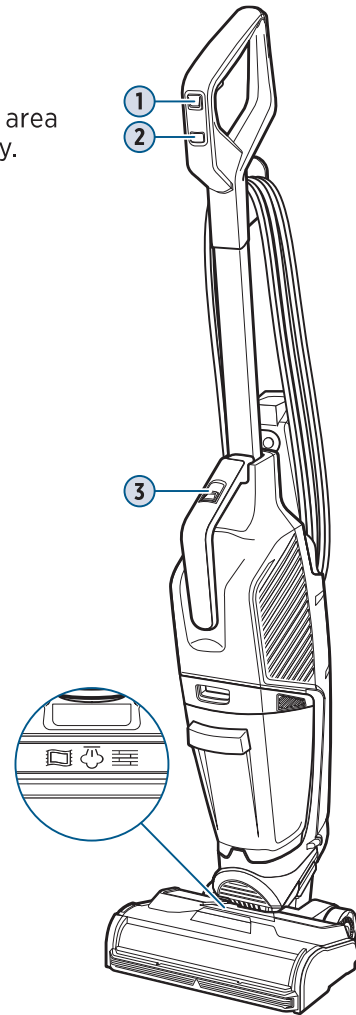

Clean everyday messes on sealed hard floors such as tracked-in mud, spilled cereal and milk, coffee, and cooking splatters.



Cleaning Your Floors

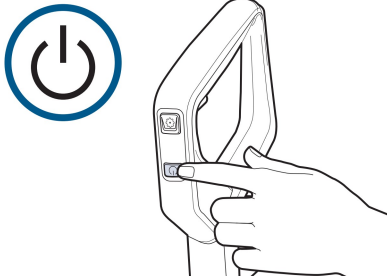
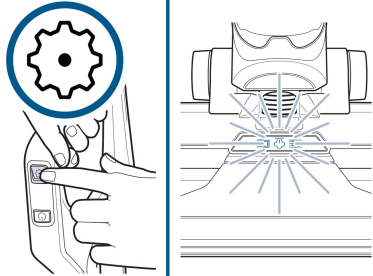
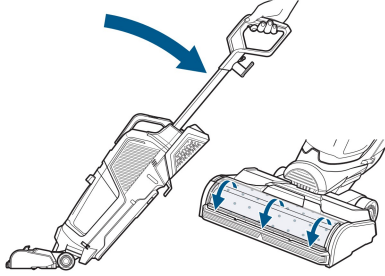
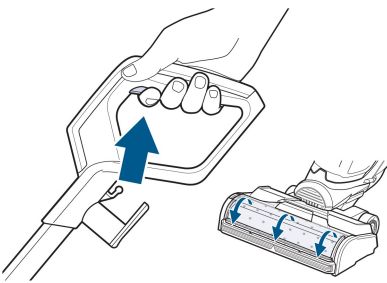

▶ For cleaning tips for stuck-on messes and more, visit support.BISSELL.com.

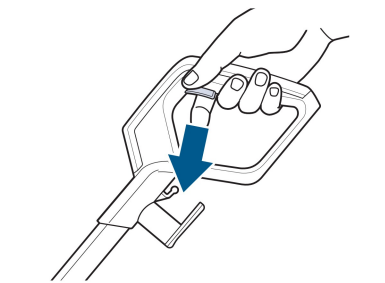
Note: Before cleaning area rugs, check the manufacturer's tag and test an inconspicuous spot on the rug for colorfastness. Don't use on silk or delicate rugs.

		
<p>1. Plug machine into a properly grounded outlet. Press power button to turn machine ON and OFF. When powered ON, starts in SteamWash mode.</p>	<p>2. Press mode button to switch between modes. See page 6 for cleaning mode information. Mode selection appears on foot display. If you chose SteamWash™, wait 30 seconds for it to warm up. The steam ready light will illuminate.</p>	<p>3. Recline machine to start brush roll spinning. When machine is standing upright, brush roll will not spin.</p> <p>Note: When returning to the upright position, continue to push machine forward after the click until machine is secured.</p>
		
<p>4. Before each use, hold solution spray trigger for 10 seconds to wet the brush roll. Note: Bubbles will appear in brush roll window when solution is flowing. Water on floor during steam cleaning is normal.</p>	<p>5. Hold trigger to dispense formula for all cleaning modes and to dispense formula plus steam in SteamWash mode. Make forward and backward passes to clean your floors.</p>	<p>6. To dry floor, release trigger to stop dispensing solution and steam. Make forward and backward passes to suction up excess water.</p>

Sanitizing Hard Floors

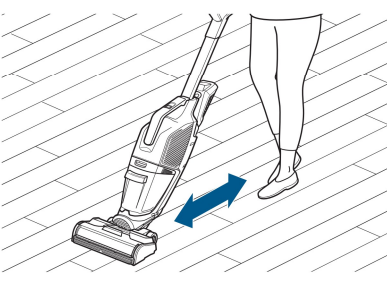
Please read the Hard Floor Sanitize formula label prior to each use. Use on hard nonporous floors only.

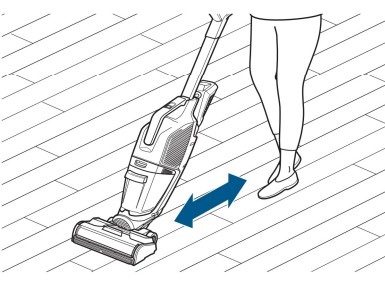
		
<p>1. Follow cleaning instructions above to remove visible soils. To sanitize: Hold trigger to apply solution to floor.</p>	<p>2. Allow floor to remain visibly wet with formula for five minutes. This may require additional passes.</p>	<p>3. With trigger released, make forward and backward passes to extract solution.</p>

Emptying the Dirty Water Tank

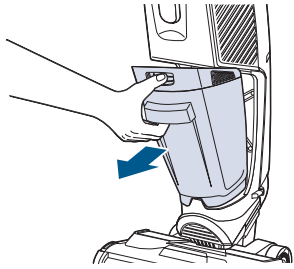
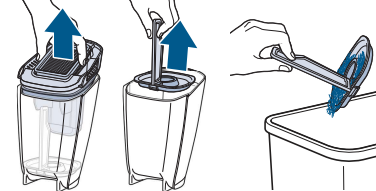
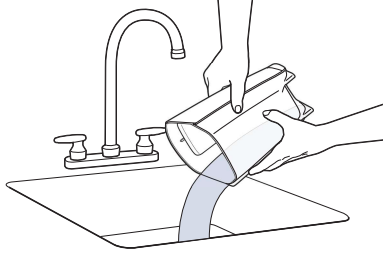
		
<p>1. Press the button on the top of dirty water tank, grab the front handle and pull out.</p>	<p>2. Hold top of tank near the sides of the filter and pull up to remove. Pull strainer stem and remove from the tank. Throw debris into the trash.</p>	<p>3. Pour dirty water into a utility sink or similar wastewater receptacle. Thoroughly rinse the tank.</p>

Using the Clean Out Cycle

Note: Empty dirty water tank before beginning and be sure the strainer and filter stay dry. Use the Clean Out Cycle after each use.

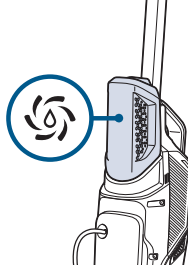
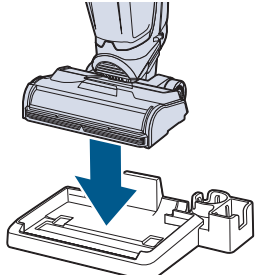
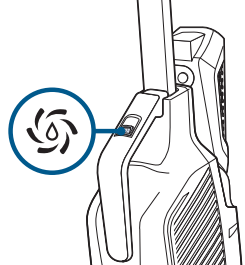
		
<p>1. Fill clean tank with water and formula up to the Clean Out fill line. Optional: With the unit removed from the tray, add 2 fluid ounces of FreshStart™ formula to the Clean Out Tray.</p>	<p>2. Plug machine into a properly grounded outlet and place on the tray. The Clean Out Cycle button on the handle will light up blue when ready.</p>	<p>3. Press the Clean Out Cycle button to begin. Note: For best results, never run the cycle more than twice.</p>

⚠ WARNING To reduce the risk of fire, electric shock or injury, turn power OFF and disconnect plug from electrical outlet before performing maintenance or troubleshooting.

After-Cleaning Care

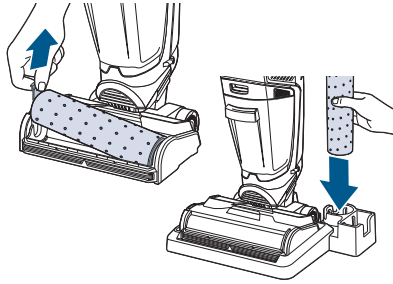
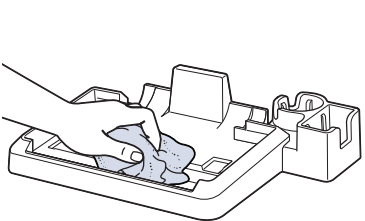
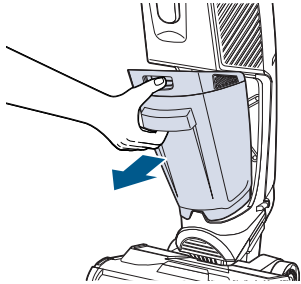
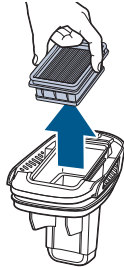
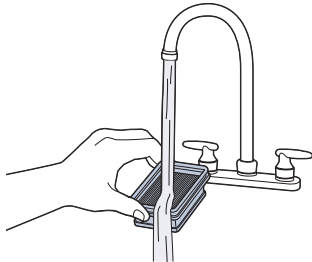
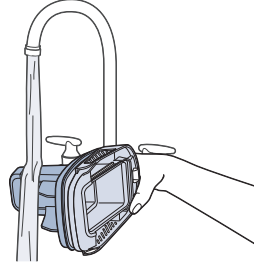
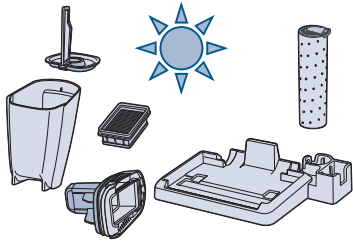
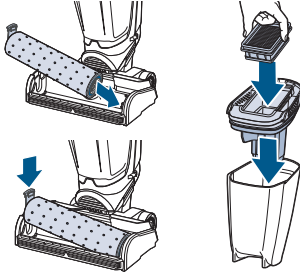
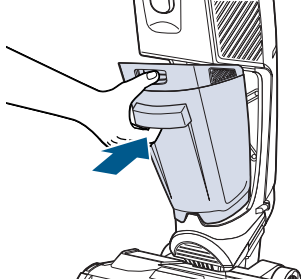
		
<p>1. Remove brush roll following steps on page 3. Pull brush roll tab and place in tray to dry. Check steam bar for clogs. Wipe steam nozzle with cloth.</p>	<p>2. Remove machine from tray and wipe excess water or dirt. Do NOT rinse under faucet.</p>	<p>3. Empty dirty water tank and strainer following steps on page 6.</p>
		
<p>4. Remove filter from lid. Open screen and remove debris.</p>	<p>5. Wash filter in warm water and mild detergent. Clean and dry filter after each use. Replace every 3 months.</p>	<p>6. Rinse the bottom of the tank cover to remove wet debris.</p>
		
<p>7. Let parts air dry for 24 hours before next use.</p>	<p>8. Reinstall brush roll following steps on page 3. Reinstall filter, strainer, and tank lid.</p>	<p>9. Insert bottom of tank first. Pivot top toward the machine until it clicks.</p>

Storing Your Machine

When finished using the product, wrap cord around cord wrap for storage. Store machine indoors in a dry location in an area where the product is not likely to get damaged.

NOTICE To reduce the risk of a leaking condition, do not store machine where freezing may occur. Damage to internal components may result.

⚠ WARNING To reduce the risk of fire, electric shock or injury, turn power OFF and disconnect plug from electrical outlet before performing maintenance or troubleshooting.

Troubleshooting

Below are some of the issues you may run into. If you don't see the issue you're experiencing below, **scan the QR code** or visit **support.BISSELL.com**.



Problem	Possible Cause	Remedies
Streaking OR loss of suction power	Too much solution dispensed.	Go over area without spraying solution.
	Brush roll window is not latched.	Reinstall brush roll window.
	Debris channel in foot is clogged.	Clean channel with a paper towel.
	Filter is clogged by debris and/or is wet.	Remove debris clogging filter screen. Clean and dry filter.
	Brush roll is wet and dirty.	Clean and dry brush roll.
No spray or steam	Clean water tank is not seated properly.	Remove and reseal tank.
	Not holding trigger to spray solution.	Hold trigger continuously while using machine.
	SteamWash™ is turned off.	Press mode button on handle to change to SteamWash mode. Ensure steam indicator light is on.
	Steam system is not primed.	Prime machine by holding trigger for 30 seconds, expelling steam.
	Steam ports are clogged.	Wipe underside of front steam bar with a wet towel.
Leaking	Clean water tank or lid is damaged.	Remove tank from machine and inspect for damage on tank and/or lid. If damage is found, contact us.
	Dirty water tank is damaged.	Remove tank from machine and inspect for damage. If damage is found, contact us.
	Dirty water tank is full.	Empty tank following steps on page 8.
Brush roll isn't turning	Brush roll is not installed properly.	Reinstall brush roll following steps on page 4.
	Machine is standing upright.	Recline machine to turn brush roll on.
	Brush roll stalled by debris.	Unplug machine and remove brush window and brush roll to remove obstruction.
Clean-Out Cycle not working	Machine is not on storage tray / machine is not plugged in.	Place machine on storage tray and plug in.
	Clean tank low.	Refill tank.
	Dirty water tank is full.	Empty tank before starting the Clean-Out Cycle.
Machine won't turn ON	Brush roll stalled by debris.	Unplug machine. Remove brush window and brush roll to remove obstruction.
	Handle not installed properly.	Reinstall handle and push down until it clicks into place.
Drips on floor during cleaning	Cleaning with water only.	Add BISSELL cleaning formula to tank.
	Holding trigger after cleaning pass.	Release trigger to stop dispensing solution and steam, making forward and backward passes to suction excess water.
Brush roll stops turning unexpectedly and motor continues to operate	Machine is overheating.	Unplug machine from power and allow to cool.

Note: Any other servicing should be performed by an authorized service representative.

⚠ WARNING To reduce the risk of fire, electric shock or injury, turn power OFF and disconnect plug from electrical outlet before performing maintenance or troubleshooting.



We're Waggin' Our Tails!

BISSELL proudly supports BISSELL Pet Foundation® and its mission to help save homeless pets. When you buy a BISSELL® product, you help save pets, too. We're proud to design products that help make pet messes, odors and pet homelessness disappear.

Visit [BISSELLsavespets.com](https://www.bissellsavespets.com) to learn more.

But wait, there's more!

Join us online for a complete guide to your new product, including troubleshooting, product registration, parts, and more.

Go to [support.BISSELL.com](https://support.bissell.com).



REGISTER



INFO



VIDEOS



PARTS



SUPPORT



©2023 BISSELL Inc. All rights reserved.
Part Number 1630880 10/22 RevJ